

# FOT-200

## TOTAL FLOOD FIRE SUPPRESSION SYSTEMS

DESIGN, INSTALLATION, AND MAINTENANCE MANUAL



**FOT**<sup>®</sup> FIRE CONTROL  
...excellence in fire suppression

**FOT-200**

www.fotfirecontrol.co.uk | sales@fotfirecontrol.co.uk | +44 333 2244 360

## **INTRODUCTION**

FOT-200 fire extinguishant is a clean, safe firefighting suppressant for use in total flooding automatic suppression systems. It is intended as a long term replacement for Halon 1301 and has excellent fire suppression properties of Halon and has none of the environmental problems. Storage and distribution requirements are similar to Halon and the majority of system components are identical. However, FOT-200 fire extinguishant is not a direct replacement for existing Halon 1301 installations due to the difference in agent quantity and discharge characteristics.

The US Environmental Protection agency (EPA) accepts use in normally occupied areas where the concentration does not exceed 9%. The safe use criteria have further been confirmed by the Halon alternative group (Hag) report. Refer to NFPA 2001, "Clean agent Fire Suppression Systems," for additional exposure requirements.

The systems described in this manual are 'engineered'. Engineered systems for example, may consist of several FOT-200 fire extinguishant containers, modularized or manifolded together and connected with a pipe network to a specified number of discharge nozzles.

## **APPROVALS AND STANDARDS**

The manufactured equipment and the FOT-200 fire extinguishant have comprehensive approvals and listings providing further support to the overall product.

*FOT-200 Total Flood  
Fire Suppression System Manual*

FOT-200 fire extinguishant is manufactured in strict accordance with the internationally recognized Quality assurance Standard, BS EN ISO 9000 and approved to ISO 9001.

FOT-200 systems must be designed, installed, inspected, maintained, tested and recharged by qualified, trained personnel in accordance with NFPA 2001, "Clean agent Fire Extinguishing Systems".

## **HEALTH AND SAFETY**

a properly designed and installed fire suppression system should not present any significant health or safety problems, however, there are basic precautions to be taken to avoid accidents, and aspects of the system operation that should be understood. End-users often require reassurance regarding the safety of personnel, and this can only be given if a thorough understanding of the properties of the agent and its effects in different situations are known. Best practices should be observed.

FOT-200 fire extinguishant can decompose at high temperatures to form halogen acids. If so, their presence is readily detected as a sharp, pungent odor long before hazardous maximum exposure levels are reached. Fire toxicity studies conclude that generally decomposition products from the fire itself, especially carbon monoxide, smoke, heat, and oxygen depletion, create a greater hazard.

The noise created by the FOT-200 fire extinguishant discharging can be loud enough to startle people in the vicinity, but is unlikely to cause any permanent injury. Turbulence caused by the high velocity discharge can dislodge substantial objects directly in its path, and cause enough general turbulence within the protected area to move paper and light objects.

### FOT-200 FIRE EXTINGUISHANT CLEAN AGENT CHARACTERISTICS

FOT-200 fire extinguishant (HFC-227ea) is a clean agent containing no particles or oily residues. It is produced under ISO 9002 guidelines to strict manufacturing specifications ensuring product purity. FOT-200 fire extinguishant leaves no residue or oily deposits on delicate electronic equipment, and can be removed from the protected space by ventilation.

FOT-200 fire extinguishant is thermally and chemically stable, but without the extremely long atmospheric lifetimes associated with some other clean agents. The atmospheric lifetime of the clean agent has been determined to be 36.5 years.

Typical areas to be protected by an FOT-200 fire suppression system are listed below:

- Bank Vaults
- Libraries
- Rare Book Stores
- Electronic Data Processing
- Telephone Exchanges
- Studios
- Communication Centers
- Transformer and Switch rooms
- Control Rooms
- Test Laboratories
- Flammable Liquid Stores

Complete suppression using FOT-200 fire extinguishant has the following advantages:

- Less visual obscurity and minimal risk to personnel
- Low toxicity
- Most effective when used with automatic detection to introduce the agent within a 6-10 second discharge
- Ability to prevent re-ignition providing concentration levels are maintained

FOT-200 fire extinguishant is stored as a liquified compressed gas and is discharged into the protected area as a vapor. It is stored in approved DOT, TUV or TC containers and is super - pressurized with dry nitrogen to 25 bar at 21 °C (360 psi at 70 °F).

### **WARNING**

FOT-200 fire extinguishant shall not be used on fires involving the following materials unless they have been tested to the satisfaction of the authority Having Jurisdiction:

- Certain chemicals or mixtures of chemicals, such as cellulose nitrate and gunpowder, that are capable of rapid oxidation in the absence of air
  - Reactive metals such as lithium, sodium, potassium, magnesium, titanium, zirconium, uranium and plutonium
  - Metal hydrides
  - Chemicals capable of undergoing autothermal decomposition, such as certain organic peroxidase and hydrazine
  - Not suitable for deep seated fires
-

AGENT PHYSICAL PROPERTIES

TABLE 1-1: FOT-200 AGENT PHYSICAL PROPERTIES

## Properties

Chemical Name	HFC227ea
Empirical Formula	CF <sub>3</sub> -CHF-CF <sub>3</sub>
Molecular Weight	170.03
Boiling Point	-16.36°C
Freezing Point	-131°C
Viscosity Liquid (25°C)	0.226Cp
Vapor Pressure (25°C)	457.7KPa
Extinguishing Concentration (Cup)	6.5%
NOAEL (V/V)	9%
LOAEL (V/V)	10.5%
LC50 (V/V)	>80%
Ozone Depleting Potential	0

**AGENT CONTAINER AND VALVE ASSEMBLY**

The container assembly consists of a container fitted with a valve and internal siphon tube, factory filled with FOT- 200 fire extinguishant agent, and super-pressurized with dry nitrogen to 25 bar at 21 °C (360 psi at 70 °F). Containers sharing the same manifold shall be equal in size and fill density. Containers are finished in red and are available in various sizes. a nameplate is mounted to the container displaying the agent weight, tare weight, gross weight, fill density, charge date and fill location. a low discharge pressure switch and liquid level indicator are options that may be specified when ordering.



**Container and Valve Assembly Technical Information**

Nominal working pressure:	25.0 bar at 21 °C (360 psi 70 °F)
Max. system pressure:	34.0 bar (482.6 psi)
Max. fill density	1 kg/L (62.4 lb/ft <sup>3</sup> )
Min. fill density	0.5 kg/L (31.2 lb/ft <sup>3</sup> )
Temperature rating	0 °C to 54 °C (32 °F to 130 °F)

**Technical Information**

The containers are manufactured in accordance with EN324 or EN13322 & 406.



	4BW500	4BW450
Hydraulic test pressure:	69.0 bar (1000 psi)	62.1 bar (900 psi)
Maximum service pressure:	34.5 bar at 21 °C (500 psi at 70 °F)	31.0 bar at 21 °C (450 psi at 70 °F)
Material:	Carbon Steel	Carbon Steel

**AGENT CONTAINER AND VALVE ASSEMBLY:**

Part No. (Nominal Volume)	Minimum and Maximum Fills kg	Valve Size mm (in)	Height from floor to outlet (nominal)		Diameter		Nominal Tare Weight kg
			mm	(in)	mm	(in)	
FOT-1011-39-8L -C (8 litre)	4.0 to 9.6	25 (1")	304	(12")	254	(10")	14.8
FOT-1011-12-16L -C (16 litre)	8.0 to 19.2	25 (1")	502	(19.8")	254	(10")	18.4
FOT-1011-13-32L -C (32 litre)	16.0 to 38.4	25 (1")	833	(32.8")	254	(10")	26.1
FOT-1011-14-52L -C (52 litre)	26.0 to 62.4	50 (2")	596	(23.5")	406	(16")	49.1
FOT-1011-15-106L -C (106 litre)	53.0 to 127.2	50 (2")	1021	(40.2")	406	(16")	71.8
FOT-1011-17-147L -C (147 litre)	73.5 to 176.4	50 (2")	1354	(53.3")	406	(16")	89.9
FOT-1011-18-180L -C (180 litre)	90.0 to 208	50 (2")	1634	(64.3")	406	(16")	105.8
FOT-1011-19-343L -C (343 litre)	172.0 to 386	75 (3")	2050	(80.7")	517	(20")	207.0

**CONTAINER LABELS**

The container label details the weight of FOT-200 agent contained, empty weight, fill density and charge date.

PART NUMBER  FOT-200 WEIGHT  TARE WEIGHT  GROSS WEIGHT  FILL DENSITY  CHARGE DATE  FILL LOCATION	KG  KG  KG  KG/L	 <p>CONTAIN FOT-200 (HFC227EA) SURPPRESSURIZED TO 25 BAR AT 21°C</p>	 Cleans Extinguishing Agent  LISTED  USE AT TEMPERATURE RANGE OF 0°C TO 54°C OPERATING PRESSURE OF 25 BAR AT 21°C. DOT 4BW500 AND EN13322-1 COMPLIANT.  ENVIRONMENTALLY FRIENDLY FIRE SUPPRESSION AGENT
<p><b>ABC</b> CARBONACEOUS MATERIALS, FLAMMABLE LIQUID AND GASES, AND FIRE IN ELECTRICAL</p>		<p><b>WARNING:</b> The discharge of clean agent systems to extinguish a fire can result in a potential hazard to personnel from the natural form of clean agent or from the products of combustion that result from exposure of the agent to the fire or hot surfaces. Unnecessarily exposure of personal either to the natural agent or to the products decomposition shall be avoided.</p>	
<p><b>MAINTENANCE:</b> Carefully follow the instruction below and those contained in the design manual. Inspect the system frequently and check the pressure gauge weekly. Check agent quantity and pressure every six months. 1. If the pressure gauge indicates a loss of pressure (when adjusted for temperature) of more than 10% then recharge with oxygen free nitrogen to 25 bar at 21°C, adjusted for temperature (Refer to table in a design manual). 2. If the loss in weight is more than 5% of the agent weight indicated on this, the unit must be recharged</p>		<p><b>RECHARGE INSTRUCTIONS:</b> RECHARGE IMMEDIATELY AFTER USE. This container should be recharged by a qualified and approved recharge agent or distributors in accordance with approved recharge procedures established by FOT Fire suppression.</p> <ol style="list-style-type: none"> <li>1. Remove actuators from each valve</li> <li>2. Disconnect container from the discharge piping and fit anti-recoil cap before remove the container from mounting bracket.</li> <li>3. Inspect the container strictly in accordance with En 1803 or equivalent for external signs corrosion damage, etc. If exposed to fire, the container must be hydrostatically tested by qualified personnel.</li> <li>4. Refurbish valve and refill in accordance with the refill procedure with the quality of agent as indicated. Super pressurable with oxygen-free nitrogen to 25 bar at 21°C, adjusted for temperature (refer to table in design manual)</li> <li>5. Refit the recoil cap and check all joints for leaks with a leaks detector.</li> <li>6. Enter date of recharge on record tag.</li> <li>7. Firmly reinstate container in its original location before removing anti-recoil cap.</li> <li>8. Refer to the design manual before connecting the charged container to the system piping and before refitting pneumatic/manual/electrical actuator.</li> </ol>	
<p style="text-align: center;"><b>RECYCLING PROJECTS THE ENVIRONMENT</b></p> Discharge only in case of fire. If container contents must be remove for service, maintenance or dismantling, contact system installer or manufacturer for instructions on reclaiming FOT-HFC227ea. CONTAINS FLUORINATED GREENHOUSE GASES COVERED BY THE FOT PROTOCOL		 <p>www.fotfirecontrol.co.uk sales@fortfirecontrol.co.uk Unit 3 Merchant, Evegate Business Park, Smeeth Ashford Kent, Tn24 9RS U.K</p>	
<p style="text-align: center;"><b>Fot-200 SHOULD ONLY BE DISCHARGED IN RESPONSE TO A CONFIRMED FIRE</b></p>		<p style="text-align: center;"><b>DO NOT COVER, REMOVE, OR DEFACE THIS LABEL</b></p>	

CONTAINER LABEL

**DOOR NOTICE**

A door notice is required at each entrance of the hazard area to advise personnel that they are entering a protected area.

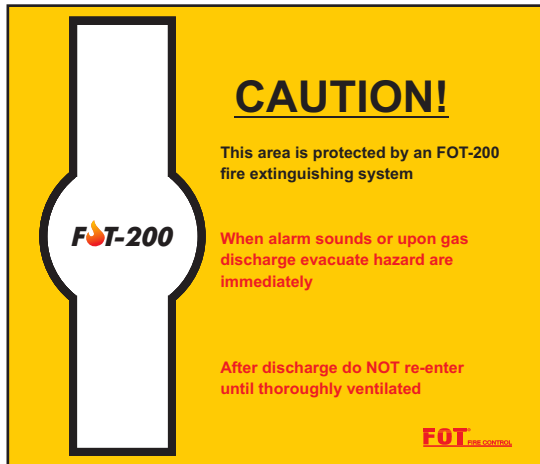

**DOOR NOTICE (GREATER THAN NOAEL)**

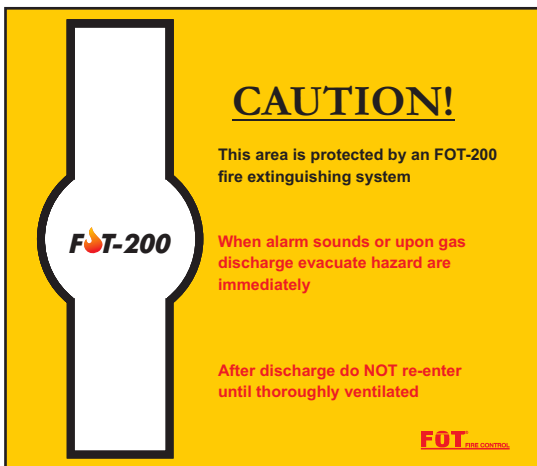

**DOOR NOTICE (LESS THAN NOAEL)**

**MANUAL RELEASE NOTICE**

A notice should be located at each manual release position.



**MANUAL RELEASE SIGN**



**TYPICAL MANIFOLD SYSTEM**

Typical two container system complete with electrical actuation, manual actuator, discharge pressure switch, low pressure switches, flexible connections, distribution pipework and nozzles.

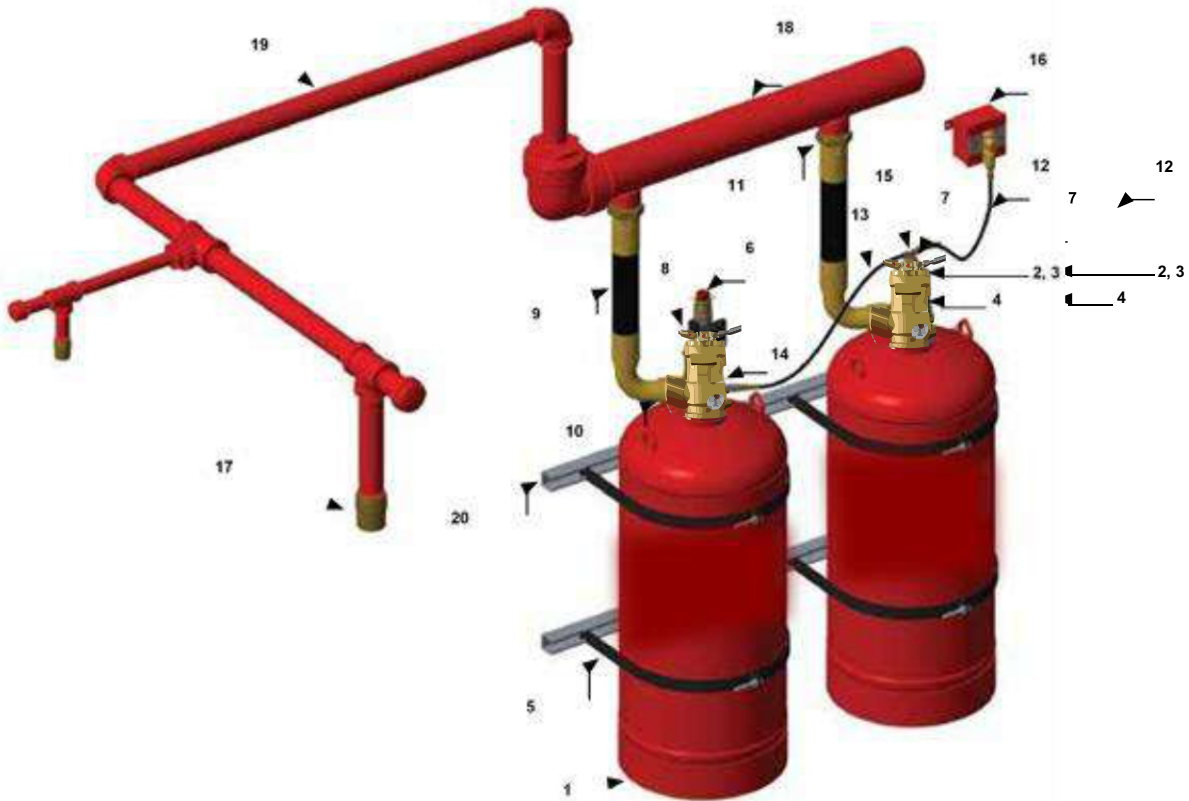

Item No.	Description
1	Container
2	Container Valve
3	Burst Disc
4	Low Pressure Switch
5	Mounting Brackets
6	Manual actuator
7	Pneumatic actuator
8	Electrical actuator
9	Flexible Discharge Hose
10	Union adaptor
11	Manifold Check Valve

Item No.	Description
12	actuation Hose
13	Female actuation hose
14	Male adaptor and Male actuation Connector
15	Male actuation Tee
16	Discharge Pressure Switch
17	Discharge Nozzle
18	Manifold (supplied by others)
19	Pipe and Fittings (supplied by others)
20	Back Channel (supplied by others)

## DESCRIPTION OF FOT-200 SYSTEMS

FOT-200 systems are designed to suppress fires in Class a, B, and C hazards.

### ! CAUTION

FOT-200 agent is not effective on the following:

- Class A Deep seated fires
- Class D Combustible metals
- Chemicals capable of auto-thermal recombination
- Chemicals capable of rapid oxidation
- Enclosures with hot surfaces (> 400 °C) (752 °F)

FOT- 200 fire extinguishant agent suppresses fires by a combination of physical and chemical means. It does not significantly deplete the oxygen content in the room.

a system consists of one or more containers connected to a system of piping and nozzles. The agent is liquefied compressed gas, super-pressurized with nitrogen pressure and stored in steel containers, each of which is fitted with a valve specially designed to allow the contents of the container to discharge within 10 seconds. When the valve opens, the agent flows into the distribution piping and then to the discharge nozzles where it is rapidly dispersed as a vapor.

Discharged FOT- 200 fire extinguishant gives the appearance of a fog which may reduce visibility. This normally clears rapidly and should not obstruct the ability of personnel to safely exit the protected area.

## TYPE OF SYSTEM

Total flooding is the approved type of system available. a total flooding system normally consists of a fixed supply of agent connected to piping with nozzles which will direct the agent into an enclosed hazard space. In a total flooding system, the enclosure around the hazard must be tight enough to hold the required percentage of agent concentration for a period of time to suppress the fire.

## TYPES OF ACTUATION

There are three basic types of actuation for the FOT-200 systems: electrical, mechanical, and pneumatic.

### Electrical

automatic electric actuation of the cylinder valve, through an approved control panel, can be accomplished by using an electric actuator. The actuator is energized by an electric signal from the detection/control panel. When using the electric actuator, a mechanical actuating device can be attached as a secondary means of actuation. When using electric actuation, a means of manual release must also be provided.

### Mechanical

Mechanical actuation is accomplished by means of a local manual actuator mounted on top of the container valve or on top of the electric actuator. The container is actuated by removing the safety pin on the actuator and depressing the strike knob. The pin in the actuator opens the container valve, allowing the container to discharge the agent.

### Pneumatic

Pneumatic actuation is accomplished with the AUTOMAN II-C Release and pneumatic actuators on the container(s).

## TYPES OF DETECTION

The approved type of detection available for the FOT-200 system is by use of an electronic control panel.

### Electronic Control Panel

Available detection devices include: ionization smoke detectors, photo- electric smoke detectors, flame detectors, and rate compensated heat detectors.

**Note:** When designing the system, make certain the type of detector used is appropriate for the type of hazard so proper response is attained in a fire situation.

## INTRODUCTION

Planning for the design and installation of an FOT-200 system should start when the customer is first contacted in regards to protecting his/her hazard with the FOT-200 fire extinguishant agent. Most of the information needed for the design of a system is collected during the first meeting with the customer. The information gathered at this point will determine the ease or difficulty of the rest of the project. One of the key elements for fire protection is to correctly define the hazard and conduct a complete survey to determine if the system will properly protect the hazard. Coordination with all parties involved in the project will further improve the flow of the overall project.

a thorough hazard analysis is required to determine the amount of protection required. It is important to cover each element and accurately record the information. This information will be used to determine the size and location of the FOT-200 system and can be used to determine if any changes were made to the hazard after the system was installed. Information necessary for the design of a system is listed in the following paragraphs.

### Hazard Information:

1. Secure the general arrangement drawings of the areas to be protected.
2. If the general arrangement drawings do not include all of the necessary information, then you must obtain it.
3. Record all dimensions of the hazard areas such as length, width, ceiling height, angles of corners if not 90° etc.
4. Draw a sketch including plan and elevation views of the hazard area if drawings are not available.
5. Indicate the quantity and location of all exits from the hazard area on the sketches.
6. Record all dimensions for any structural objects such as beams or columns, built-in cabinets, ducts, etc. which may allow a reduction of the hazard volume.
7. Identify anything unique about the hazard area that would affect system design or installation.
8. Identify the normal, maximum, and minimum ambient temperatures of the hazard area.
9. Will the hazard area normally be occupied?
10. Identify any openings or potential openings in the hazard enclosure that may cause loss of agent during or after discharge.

11. Identify all potential fire hazards and determine the corresponding agent concentration requirements. Select the highest design concentration determined for protection of the hazard area.

### Piping and Wiring Information:

1. Determine the container location
2. Identify preferred supply piping routes
3. Indicate any obstructions to the piping or wiring runs
4. Distribution piping will be installed only with approved piping
5. Pipe size reductions may be made by using reducing tees, bushings or couplings

**Hazard Structure and Contents:**

1. The protected enclosure shall be bounded by rigid elements of building construction. The ceiling should not be less than 305 mm (12 in.) above the hazard.
2. During agent discharge, the hazard enclosure will experience a pressure change. The hazard structure must be capable of withstanding a pressure of 600 pa (0.087 psi) developed during discharge.
3. In total flooding applications, the hazard area must be an enclosed space with no significant openings so that the design concentration can be achieved and maintained. generally, the calculation is based on an empty area; subsequent furniture and fittings having little effect on the actual concentration.
4. Similarly, large equipment cabinets and control panels should not be considered in the calculation as it is assumed that the internal area is required to be filled with agent.
5. Each enclosed space is considered as a hazard area and requires at least one nozzle. a subfloor, false ceiling, cable duct, etc. is treated as a separate adjacent area and requires simultaneous discharge to occur.
6. Ceiling obstructions such as beams that are less than 305 mm (12 in.) below the slab do not need to be considered. Obstructions greater than 305 mm (12 in.) can affect the distribution of agent and may require additional nozzles.
7. Dampers should be installed in both supply and return air ducts as close as possible to the area. The duct volume between the unit and the damper must be added to the overall volume.

## SYSTEM DESIGN

There are four main elements of system design. The first is the risk assessment as described in Section 4 - Planning. The second is Room Integrity described below. The third and fourth elements of system design are explained in the remainder of this section under Design Concentration and System Limitations.

### ROOM INTEGRITY

The hazard integrity is the ability of the hazard enclosure to retain the discharged FOT-200 fire extinguishant agent. For a total flooding suppression system to be effective, the design concentration must be achieved and then maintained for at least ten minutes. The only method of testing the agent retention within the protected area is to verify the integrity of the enclosure by applying proven test procedures.

The enclosure integrity test has been developed to locate the source of leaks and, from the data collected, predict the retention time, proving system performance and removing the need for actual agent discharge.

#### Principle

The test is conducted with a device known as a door fan, which has been used in the energy conservation field for over 25 years. It has three basic components:

- An adjustable panel that fits in the doorway of the protected area
- A calibrated fixed speed fan
- A variable speed fan

The pressure created by the door fan causes the air to move through leaks in the enclosure at high speed making it easy to pinpoint where leaks exist. A cool chemical smoke or other air current indicator is used to detect the approximate size and location of leaks.

#### Equivalent Leakage Area (ELA)

The test to measure the ELA is conducted by blowing air into or out of the enclosure to develop the same pressure differential as would be created by discharging agent. By measuring the air flow required, it becomes possible to calculate the ELA, which is the total of all cracks, gaps, and holes in the enclosure. The leakage measurement achieved by taking air out of the enclosure (depressurization), and then blowing air into the enclosure (pressurization), is then averaged.

### Below Ceiling Leakage Area (BCLA)

Experience has shown that leakage above a suspended ceiling has a negligible effect on the agent concentration. FOT-200 agent tends to escape from leaks in the lower part of the enclosure caused by the weight of the mixture above it. The rate at which agent is lost is therefore primarily governed by the leakage below the floor, and walls beneath the ceiling. This is called the Below Ceiling Leakage area.

#### Predicting Retention Time

Once the ELA, BCLA and static pressures have been measured the next step is to calculate the retention time of the enclosure. The formula is derived from a standard engineering/ fluid dynamics principle. The result of the calculation is the number of minutes it takes for the agent/air interface to reach the minimum protected height required, normally about 75% of the height of the enclosure area.

#### Slab to Slab Walls

The only major limitation is that it cannot be used to accurately predict a retention time if the perimeter walls do not extend from slab to slab. The enclosure will almost invariably fail due to extensive leakage through the ceiling tiles.

#### Coordination and Planning

It is essential to ensure the enclosure is ready, and the relevant people have been informed. Having established all outstanding works are completed prior to the test date, advise all interested parties in writing, if necessary, outlining the testing method and principals involved.

### SYSTEM LIMITATIONS

The calculation method is designed for specific types of fittings, pipe, and pipe inside diameter. When these limitations are not maintained, there is a risk the system will not supply the required quantity of agent.

### Nozzle Selection and Location

The number of nozzles required is based on the hazard size and configuration and the coverage provided by the nozzle. Nozzles are available in 7 port or 8 port versions to provide 180° or 360° discharge patterns respectively. When considering the optimum nozzle location, the following factors should be taken into account.

- Nozzle location is affected by the shape of the hazard area.
- The maximum discharge radius is (see Figure 5-1):
  - 8.7 m (28.6 ft) for a 360° nozzle
  - 10.05 m (33.0 ft) for a 180° nozzle
- The maximum coverage area for either nozzle is 95.3 m<sup>2</sup> (1026 ft<sup>2</sup>).
- Nozzle orifices must not be placed where they may discharge into nearby objects.
- If nozzle velocity is a concern, the designer may wish to add additional nozzles to lower the individual nozzle velocity to an acceptable limit.
- Nozzles can be installed up to a maximum of 305 mm (12 in.) below the ceiling.
- Maximum nozzle height above floor level for a single row of nozzles is 4.87 m (16 ft). For ceiling heights over 4.87 m (16 ft) additional rows of nozzles may be added.
- 180-degree nozzles must be mounted within 305 mm (12 in.) of the wall and must point at the center of the module it is protecting.
- The minimum ceiling height, (e.g. Sub-floors, false ceilings, plenums) is 305 mm (12 in.).
- Sub-floor nozzles may be positioned either vertically down (Pendant style) from the top of the sub-floor or upright mounted from the bottom of the sub-floor.
- Maximum elevation difference between the container outlet and the furthest horizontal pipe run or discharge nozzle shall not exceed 9.1 m (30 ft).
- Maximum elevation difference between the furthest horizontal pipe runs or discharge nozzles shall not exceed 9.1 m (30 ft).
- Maximum of 20 nozzles per system.
- If the room is an odd shape, the designer may wish to increase the nozzle quantity to provide a more even distribution of agent.

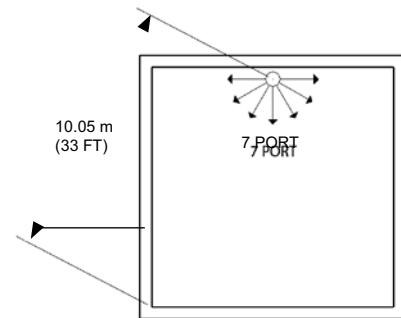
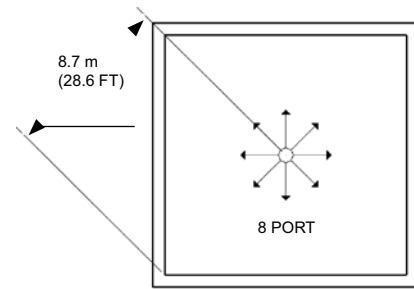

**1 NOZZLE DISCHARGE RADIUS**

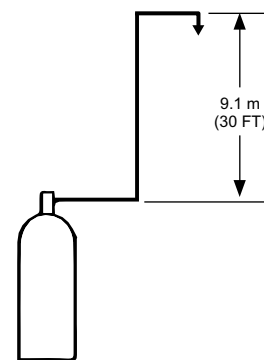

**2 MAXIMUM ELEVATION BETWEEN NOZZLES AND CONTAINER OUTLET**

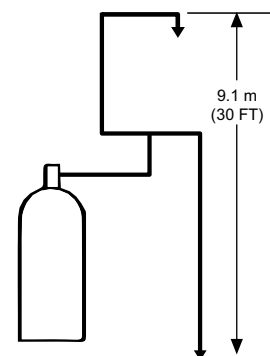

**3 MAXIMUM ELEVATION BETWEEN NOZZLES**

### **SYSTEM LIMITATIONS (Continued)**

#### **manifolds**

It may be necessary to manifold agent containers to provide the required amount of agent for a hazard, or to make available the proper increments of agent weight for the protection of multiple hazards.

Whenever containers are manifolded, the following rules must be observed.

1. all containers connected to the same manifold or pipe must be the same size and fill weight.
2. agent containers must be located in a single row and spaced according to the inlet to inlet distance.
3. a connected reserve may be employed in some circumstances providing a secondary supply of agent.
4. Flexible discharge hoses and check valves must be used at each manifold inlet.

**Piping Practices (Continued)**

**EXAMPLE: TEE SPLIT DESIGNS**

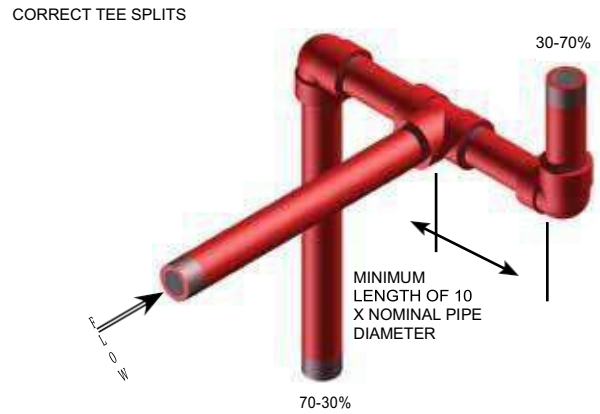
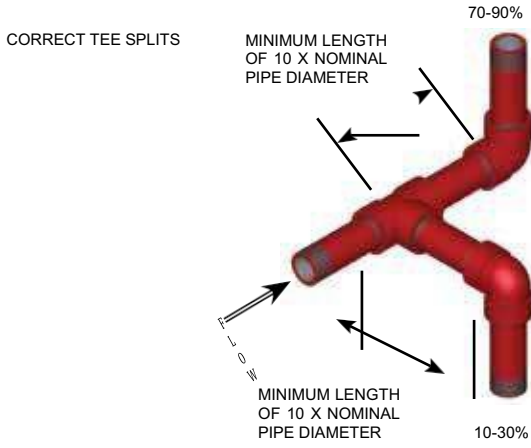

**SIDE TEE SPLIT LIMITS**

**BULL TEE SPLIT LIMITS**

INCORRECT TEE SPLITS

INCORRECT TEE SPLITS

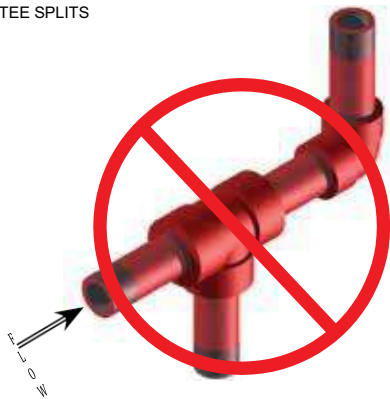

**SIDE TEE ORIENTATION "INCORRECT"**



**BULL TEE ORIENTATION "INCORRECT"**



### SINGLE CONTAINER INSTALLATION

1. Mount back channels (supplied by others) of the container brackets to the wall at the appropriate heights (see Table 6-1, next page), using suitable hardware (not supplied).
2. Position the container against the back channel with the valve outlet pointing left.
3. Insert the top and bottom container straps and secure with the bolts provided (see Figure 6-3, next page).
4. Remove the outlet safety cap from the valve outlet (see Figure 6-1).

5. **For 8 L - 180 L containers, 25 mm (1 in.) and 50 mm (2 in.) valves:** With the outlet safety cap removed from the valve outlet, install a union coupling.

### CAUTION

Do not over tighten the container connection. Excessive tightening may cause the valve outlet thread to be damaged and adversely affect system operation.

6. Install the initial pipe run and then disconnect the container and refit the outlet safety cap to the valve outlet.
7. Re-connect the pipe to the container after the pipework system is complete and the discharge nozzles have been installed.

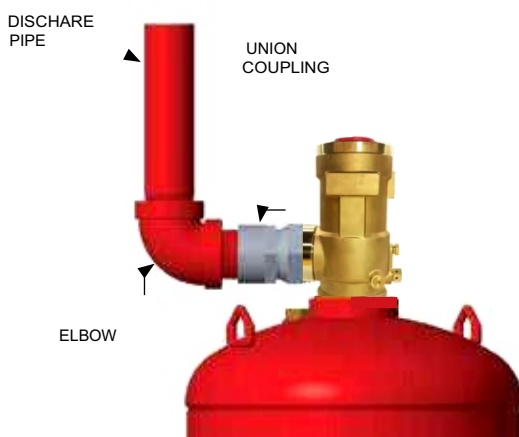
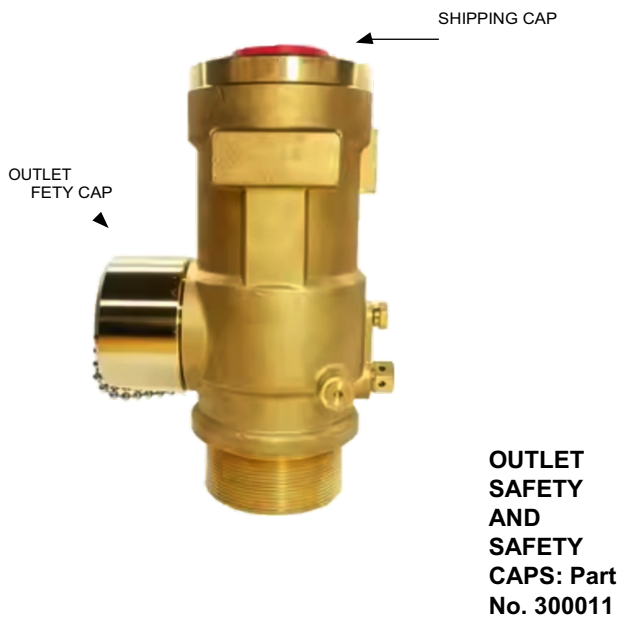

8 L THROUGH 180 L  
CONTAINERS: Part No. 300008

## SINGLE CONTAINER INSTALLATION



## INSTALLING DISTRIBUTION PIPING

### General piping Requirements (Including manifolds)

- Use Schedule 40 black iron, galvanized, chrome-plated, or stainless-steel pipe conforming to ASTM A53 or A106. All fittings must be a minimum Class 300, malleable or ductile iron.
- Pipe unions are acceptable.
- Reducing bushings and reducing fittings are allowed when reducing pipe size.
- Cast iron pipe and fittings are not acceptable.
- PTFE (Teflon) tape is the only acceptable pipe sealant and must be applied to male threads only.

### NOTICE

Do not allow tape to overlap the pipe opening, as this could cause possible blockage of the agent. **Thread sealant or compound must not be used.**

- Before assembling the pipe and fittings, make certain all ends are carefully reamed and blown clear of chips and scale. The inside of pipe and fittings must be free of oil and dirt.
- All pipe lengths are measured center to center of fittings.
- Hangers must be placed within 305 mm (12 in.) of the discharge nozzle.
- Hangers must be UL listed or FM approved and mounted to a structure capable of supporting the weight of the pipe and agent.
- All dirt trap maximum lengths are 10 times nominal pipe diameter and minimum lengths are not less than 50 mm (2 in.).
- Vertical drops on the end of the line are acceptable

## MANIFOLDS

Manifolds can either be assembled from threaded pipe and fittings or be of welded construction. They enable multiple containers to be connected to a common pipe network. They may also be used in systems where Main/Reserve container arrangements are required.

The use of elbows for installation of 25 mm (1 in.) and 50 mm (2 in.) check valves is not acceptable.

### CAUTION

- Do not allow tape to overlap the pipe opening, as this could cause possible blockage of the agent.
  - Thread sealant or compound must not be used.
  - Before assembling the pipe and fittings, make certain all ends are carefully reamed and blown clear of chips, debris and scale. The inside of pipe and fittings must be free of oil and dirt.
- 

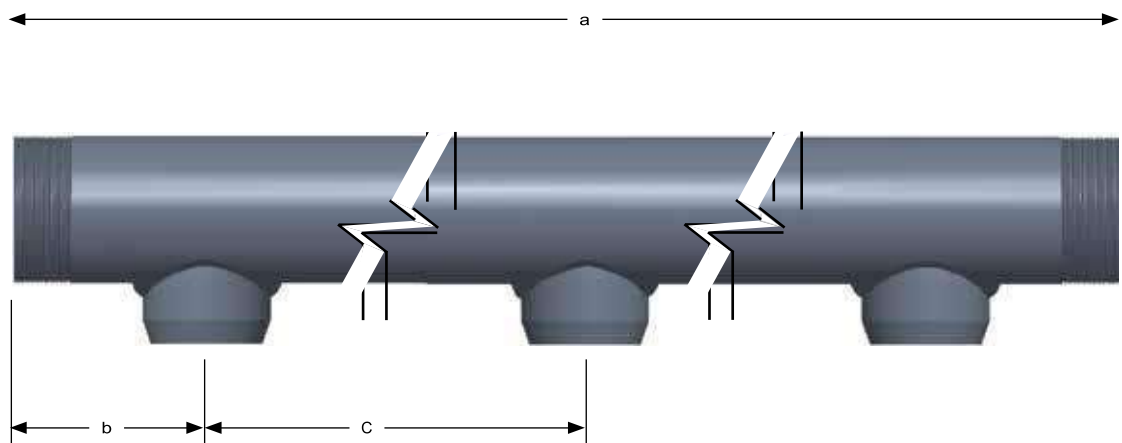

TYPICAL MANIFOLD ASSEMBLY

### **MULTIPLE CONTAINER INSTALLATION**

Containers are manifolded together for three main reasons:

- To reduce the amount of piping required by connection to a single supply pipe.
- For systems that require main and reserve.
- Combining the correct containers to obtain the required quantity of agent within a specific hazard area.

#### **Container Installation**

1. Mount the back channels (supplied by others) of the container brackets to the wall at the appropriate heights, using suitable hardware (not supplied).
2. Position the containers against the back channels with the pressure gauge facing forward at the required spacing for the manifold ports.
3. Insert the container straps at top and bottom and secure with the bolts provided.

### **MANIFOLD BRACKET INSTALLATION**

a typical manifold assembly consists of the manifold, check valves, and an end cap. Each check valve is screwed to the manifold (25 mm (1 in.) and 50 mm (2 in.) valves only).

back channels are used to ensure that the appropriate height adjustment is available when connecting the discharge hose from the valve outlet to the manifold check valve

1. Mount the two back vertical channels to the wall at the appropriate height using suitable hardware
2. Locate and secure the cantilever brackets to each channel using M10 x 40 mm (3/8 UNC x 1 1/2 in.) Hex Head screw and unistrut long spring 10 mm (3/8 in.).
3. Locate manifold brackets in cantilever channel and unistrut end caps.
4. **For 25 mm (1 in.) and 50 mm (2 in.) Valves:** Remove outlet safety cap and attach discharge hose between valve and manifold. adjust cantilever height as required and secure in position.
5. For safety remove discharge hose and replace outlet safety caps, while pipework is installed.

### PIPE INSTALLATION

- In general, the installation should begin at the union elbow/manifold assembly and progress along to the discharge nozzles. Install the Pipework to the installation drawings provided, ensuring that the following is adhered to.

#### CAUTION

- Do not allow tape to overlap the pipe opening, as this could cause possible blockage of the agent.
  - Before assembling the pipe and fittings, make certain all ends are carefully reamed and blown clear of chips, debris and scale. The inside of pipe and fittings must be free of oil and dirt
  - Thread sealant or compound must not be used
-

**PIPE INSTALLATION (Continued)**

**pipe hangers (Continued)**



**NOZZLE  
MOUNTING**



**ELBOW  
SUPPORT**

Where the design basic insulation level (bIL) is not available, and where nominal voltage is used for the design criteria, the highest minimum clearance listed for this group shall be used.

**NOZZLES**

a false ceiling with loose tiles must have the tiles retained within a 1.22 m (4 ft) radius of the nozzle including all perimeter tiles to help prevent movement during system discharge. Nozzles should be installed a maximum of 305 mm (12 in.) below the ceiling.

**EARTHING AND ELECTRICAL CLEARANCE**

Systems within electrical substations or switch rooms shall be efficiently earthed to prevent the metalwork from becoming electrically charged. adequate earthing of systems will minimize the risk of electrostatic discharge.

all system components shall be located to maintain no less than minimum clearances from energized electrical parts. The following references shall be considered as the minimum electrical clearance requirements for the installation of clean agent systems:

- ANSI C2
- NFPA 70
- 29 CFR 1910, Subpart S

## ACTUATION INSTALLATION

### Manual Actuator

Confirm actuating plungers are in the raised position. The manual actuator can be installed to the top of the electrical actuator or directly onto the valve, after first removing the protective cap.

### CAUTION

before installing the manual actuator to the electrical actuator or container valve, ensure the firing pin is retracted and the safety pin is in place. Raising the strike knob DOES NOT reset the pin. Pin must be PUSHED UP manually. Failure to reset the actuator will result in the potentially hazardous discharge of the container. The actuator must be hand-tight only. Over-tightening may damage the valve and cause actuation of the container.

### pneumatic Actuator

Check the actuating plungers are in the raised position. Remove the actuation cap from the top of the valve assembly and carefully screw the pneumatic actuator to the valve on each slave container.

### CAUTION

before installing the manual actuator to the electrical actuator or container valve, ensure the firing pin is retracted and the safety pin is in place. Pin must be PUSHED UP manually. Failure to reset the actuator will result in the potentially hazardous discharge of the container. The actuator must be hand-tight only. Over-tightening may damage the valve and cause actuation of the container.

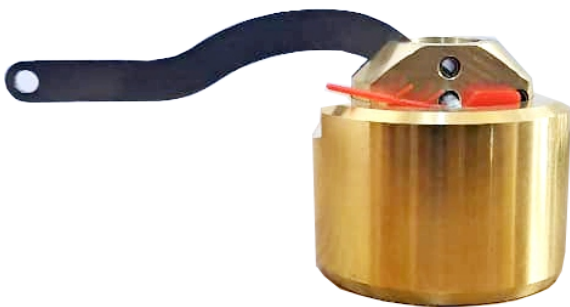

MANUAL ACTUATOR NON-FIRED  
POSITION



PNEUMATIC ACTUATOR NON-FIRED  
POSITION



MANUAL ACTUATOR  
INSTALLED



PNEUMATIC ACTUATOR  
INSTALLED

### ACTUATION INSTALLATION (Continued)

#### Multiple Container Actuation

Where several containers comprise one system and are discharged simultaneously, one container is designated as the 'master' container, and the others are 'slave' containers. The master container can be actuated electrically or manually. The slave containers are actuated pneumatically by the action of the master container discharging.

#### Slave Actuation Line

For slave containers the pneumatic connection is made using flexible actuation hoses. To install the actuation hoses, replace the 1/4 in. actuation pressure port plug on the master container valve assembly.

The maximum number of slave actuated containers is 9 (total of 10 containers). after every 10 containers another master container must be created, using an electrical actuator. all the electrical actuators must operate simultaneously to ensure the correct discharge time.



**MULTIPLE CONTAINER  
ACTUATION**



**ANCILLARY EQUIPMENT**

**discharge pressure Switch**

**SINGLE CONTAINER SYSTEMS**

On single container installations the discharge pressure switch should be located close to the valve assembly and connected with an actuation hose from the pressure port outlet on the valve to the connector on the discharge pressure switch.



**DISCHARGE  
PRESSURE SWITCH  
INSTALLATION  
(SINGLE CONTAINER SYSTEM)**

**MULTIPLE CONTAINER SYSTEMS**

On multi-container installations the discharge pressure switch should be located close to the last slave container and connected by actuation hose to the tee connector on the pneumatic actuator.

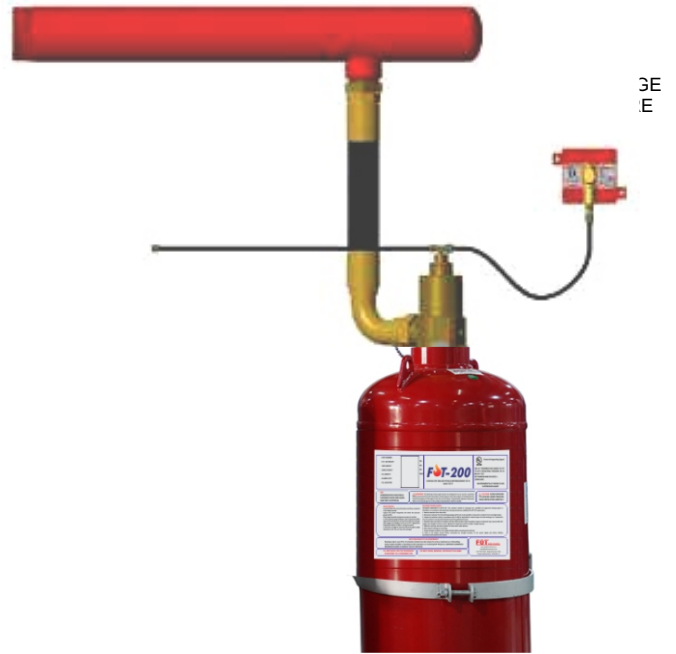

**DISCHARGE PRESSURE SWITCH INSTALLATION  
(MULTIPLE CONTAINER SYSTEM)**

**ANCILLARY EQUIPMENT (Continued)**

**discharge pressure Switch Installation**

The discharge pressure switch is designed to be mounted on any suitable flat surface, near the FOT-200 agent containers, using the two mounting tabs provided.

Ensure the container is bracketed securely before connecting the switch. For single container systems remove the plug from actuation port, fit appropriate adaptors and using either pneumatic tubing or actuation hose, connect switch to actuation port on master valve. For multiple container systems fit appropriate adaptors and using either pneumatic tubing or actuation hose, connect switch to tee on final slave container valve.

For electrical installation remove the cover plate to access the wiring terminals. Connections can be made either normally open or normally closed. See Figure 6-24. The end-of-line resistor must be installed to suit the control panel.

**Low pressure Switch**

all container valves have the option for a low-pressure warning switch (factory installed). Voltage input can be applied to either terminal.

The low-pressure switch should be connected in parallel with an end-of-line (EOL) device. This will allow the panel to differentiate between an open-circuit fault in the wiring and an actual low container pressure supervisory condition.

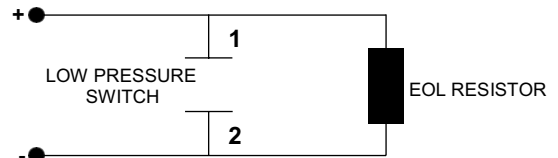

**LOW PRESSURE SWITCH WIRING**

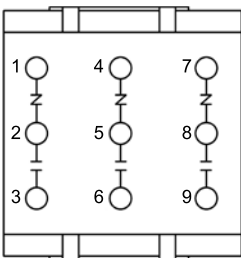

**PRESSURE SWITCH CONTACTS**

- 1: Pole 1, Normally-Closed (NC1)
- 2: Pole 1, Common (COM1)
- 3: Pole 1, Normally-Open (NO1)
- 4: Pole 2, Normally-Closed (NC2)
- 5: Pole 2, Common (COM2)
- 6: Pole 2, Normally-Open (NO2)
- 7: Pole 3, Normally-Closed (NC3)
- 8: Pole 3, Common (COM3)
- 9: Pole 3, Normally-Open (NO3)

**PRESSURE SWITCH CONTACTS**

### INSPECTION SERVICE AND MAINTENANCE

Systems shall be thoroughly inspected and tested for proper operation by qualified distributor in accordance with NFPA as well as any other standard accepted to the authority Having Jurisdiction. Before any checks are carried out, ensure the Suppression system is isolated electrically and mechanically and remove all electrical and pneumatic actuators. No maintenance work should be carried out without obtaining approval from the Responsible Person and advising any personnel within the hazard area.

#### SIX MONTH INSPECTION

Check the condition of all actuators by completing the following:

1. Remove all actuators from the container valves (electric, manual, and pneumatic).
  2. For pneumatic actuator, check the condition of each actuator to make certain they operate freely. Reset the actuator ensuring the pin is in the non-fired position.
  3. For electric actuators, make certain all wires are properly connected. Test-fire the actuator and ensure the pin operates freely. Reset the actuator ensuring the pin is in the non-fired position.
- Externally inspect containers for signs of damage or unauthorized modifications. Check container labels are securely mounted and legible. Check container brackets and fittings.
  - Examine the container pressure gauge reading and refer to the temperature correction table. If the container pressure corrected to temperature is below 10% of the stated pressure, it must be replaced or recharged.
  - Verification of FM-200 fire extinguishant agent fill weight in the containers may be achieved through either liquid level detection or container weighing. If containers exceed an agent loss of more than 5% or a pressure loss (adjusted for temperature) of more than 10%, the container should be refilled/recharged or replaced.
  - Check the condition of the piping to make certain it is properly secured in the hangers and all fittings are connected tightly. Look for signs of damage or corrosion. Repair pipework as necessary.
  - Inspect nozzles for dust and debris, clean out where necessary, and ensure correct distribution pattern, nozzle orifice code, and orientation.
- Carry out a full visual check of the enclosure for integrity and confirm the dimensions and the configuration of the hazard match the latest approved drawings. If drawings are not available, dimensions and calculations should be made, per Section 5 – System Design, to validate system design.
- Check all warning signs throughout the area. Make certain they are in place, mounted securely, are readable, and are not damaged.
  - Check the condition of the control panel for tampering, corrosion, or damage. Test the panel by referring to the appropriate AUTOPULSE Control System manual.
  - Check all detectors in accordance with NFPA 72. Make certain they are in place, clean, and not damaged. If required, check the sensitivity of each per the instruction of the detector manufacturer. See appropriate AUTOPULSE Control System manual for detailed instructions.
  - While checking the detectors and electric pull station, inspect each alarm device. Check the condition of the alarm and verify correct operation when energized. Reset the alarm circuit after each test.
  - Check all manual release stations. Make certain stations are in place, and are not blocked or damaged. Operate each manual release station to confirm the control panel operation. Reset each manual release station.
  - All system hoses should be examined for damage. If visual examination shows any deficiency, the hose shall be replaced.

When a liquid level indicator is not used, then containers must be weighed to establish the FOT-200 agent content. The weighing procedure is as follows:

1. Remove all actuation devices and pneumatic actuation pipe or tubing and flexible electrical connectors.
2. Disconnect and remove discharge piping/discharge hoses from container valves.
3. Install outlet safety caps onto container valves.
4. Remove containers from bracketing and weigh containers. If the weight loss exceeds 5% of the weight of charge, the container requires recharging by a qualified recharge fill station.
5. Record weight of container on record tag.
6. Replace containers in bracketing and remove outlet safety caps.
7. Reconnect discharge piping / discharge hoses and all actuation devices. Reconnect pneumatic actuation pipe or tubing and flexible electrical connectors.

**FOT-200**

**FIRE EXTINGUISHANT  
SAFETY DATA  
SHEET (SDS)**

**FOT<sup>®</sup>** FIRE CONTROL

...excellence in fire suppression

## Section 1 – Company and Chemical Identification

### FOT Fire Control

Unit 3 Merchant Evegate  
Business park, Smeeth Ashford,  
Kent TN24 9RS England.

Issue Date: 24/02/18  
www.fotfirecontrol.co.uk

**Product Name: FOT -200 1.1.1.2.3.3.3 HEPTAFLUOROPROPANE (HFC-227ea) (R227)**

## Section 2 – Hazard Identification

**Emergency Overview:** HEPTAFLUOROPROPANE is a colorless, odorless gas. The liquid or cold gas can cause chilling or possibly frostbite of exposed tissues. Inhalation of high concentrations can be harmful or fatal due to oxygen deprivation and/or heart irregularities. Fire Extinguisher cylinders are pressurized. Although unlikely, a cylinder could be propelled and cause bodily injury and/or property damage if the valve is broken due to improper handling or storage.

## Section 3 – Composition/Information on Ingredients

C.A.S.	INGREDIENT NAME	OSHA PEL	ACGIH TLV	OSHA STEL	%
431890	FOT-200 (HFC 227ea) HEPTAFLUOROPROPANE	NOT ESTAB.	NOT ESTAB.	NOT ESTAB.	> 99
7727-37-9	Nitrogen, Compressed	None	Simple Asphyxiant	N/A	1

## Section 4 – First Aid Measures

**Skin contact:** Flush with water, treat for frostbite if necessary, by gently warming affected areas. Consult a physician.

**Eye contact:** Immediately flush eyes with plenty of water for at least 15 minutes. Consult an ophthalmologist.

**Inhalation:** Remove victim(s) to fresh air, as quickly as possible. If not breathing, qualified personnel should administer artificial respiration. Get medical attention. If breathing is difficult, administer oxygen.

**Ingestion:** No first aid should be needed. Not considered a potential route of exposure.

## Section 5 – Fire Fighting Measures

**Flammability:** Not flammable.

**Conditions of flammability:** Will not burn.

**Extinguishing media:** Use appropriate extinguishing media for surrounding fire. Keep cylinders cool with water spray applied from a safe distance.

## Section 6 – Accidental Release Measures

Evacuate the area and ventilate. Do not enter areas where high concentrations may exist (especially confined or poorly ventilated areas) without appropriate protective equipment including a self-contained breathing apparatus.

### Section 7 – Handling and Storage

Handle, transport and store carefully and securely to avoid accidental knocking over or other severe physical impacts. Do not expose to direct heat sources. Do not over-pressurize.

### Section 8 – Exposure Controls/Personal Protection

**Respiratory:** None

**Protective Gloves:** Leather gloves are recommended when handling cylinders.

**Eye Protection:** Eye protection is recommended when handling cylinder

**Other Protective Clothing or Equipment:** Safety shoes are recommended when handling cylinders.

**Work Hygienic Practices:** Wash thoroughly after handling. Wash contaminated clothing before reuse.

### Section 9 – Physical & Chemical Properties

**Appearance:** Colorless gas

**Physical State:** Gas

**Odor:** Odorless

**Solubility in Water:** 260 mg/L

### Section 10 – Stability and Reactivity

**Stability:** Stable under normal conditions of handling and use.

**Conditions to Avoid:** None

### Section 11 – Toxicological Information

VALUE (LD50 or LC50)	Animal	Routes	Components
>788.696 ppm/4H	Rat	Acute Inhalation	1.1.1.2.3.3.3 Heptafluoropropane

The human health hazards of this product are expected to be similar to other liquefied gases including N<sub>2</sub>, CO<sub>2</sub>, CFCs, HCFCs, and HFCs. Therefore, direct eye or skin contact with the liquid or cold gas can cause chilling or possibly frostbite of exposed tissues. Inhalation of high concentrations can be harmful or fatal due to oxygen deprivation and/or heart irregularities (arrhythmias). Misuse of the products by deliberately inhaling high concentrations of this gas could cause death without warning. Persons with pre-existing cardiac or central nervous system disorders may be more susceptible to effects of an overexposure.

### Section 12 – Ecological Information

No ecological information is available.

### Section 13 – Disposal Considerations

Dispose of waste and empty cylinders as allowed by current Local, State/Province, or Federal laws and regulations.

### Section 14 – Transport Information

**Proper Shipping Name:**

Heptafluoropropane

**ID Number:** EN 1000

**Hazard Class:** 2.2

**Packing Group:** N/A

**Labels:** Non-flammable gas

**Packing Instructions:** 200

### Section 15 – Regulatory Information

**U.S. Federal Regulations:** The components of this product are either on the TSCA Inventory or exempt (i.e. impurities, a polymer complying with the exemption rule at 40 CFR 723.250) from the Inventory.

**State Regulations:** None Known

**Section 16 – Other Information**

**HAZARDOUS MATERIAL IDENTIFICATION SYSTEM (HMIS) CODES:**

HEALTH: 1 (slight hazard); FLAMMABILITY: 0 (will not burn); REACTIVITY: 0 (normally stable);  
PPE: See Section 8